

WA 101/WA 200/WA 200WB AUTOMATIC SPRAY GUN WA 101R ROUND PATTERN AUTOMATIC SPRAY GUN LPA 200 HVLP AUTOMATIC SPRAY GUN



GB Before use, adjustment or maintenance, it is important to read this instruction manual very carefully. This manual must be stored in a safe place for any future reference that may be necessary.

This **ANEST IWATA** spray guns kit complies to ATEX regulations 94/9/EC, protection level: II 2 G X Suitable for using Zones 1 and 2. **CE** **Ex** II 2G X X marking. Any static electricity discharge from the spray gun is to be diverted to the ground via the conductive air hose as stipulated.

IMPORTANT

This automatic spray gun should be operated only by an adequately trained operator for safe use and maintenance of the equipment. Any misuse or handling other than those indicated in this Instruction Manual is not covered by guarantee. **ANEST IWATA** disclaims all responsibility for any accident or damage caused by failure observing the operational and safety procedures as from this manual. In the interest of user friendliness, this manual contains information in a brief and concise form. For any additional information you may require regarding the automatic spray gun operations, or if any missing parts or any damage during transportation is found, or details of training courses, please contact your nearest **ANEST IWATA Company** (see last cover page).

Be sure to observe warnings and cautions in this instruction manual. If not, it can cause paint ejection and serious bodily injury by drawing organic solvent. Be sure to observe following **⚠** marked items which are especially important.

⚠ WARNING	Indicates a potentially hazardous situation which, if not avoided, may result in serious injury or loss of life.
⚠ CAUTION	Indicates a potentially hazardous situation which, if not avoided, may result in minor or moderate injury or property damage.
IMPORTANT	Indicates notes which we ask you to observe. The safety precautions in this instruction manual are the minimum necessary conditions. Follow national and local regulations regarding fire prevention, electricity and safety as well as your own company regulations.

ANEST IWATA Europe S.r.l.
46, Corso Vigevano 10155, Torino Italy
Direct Tel. +39 011 - 22 74 402
Fax +39 011 - 22 74 406
info@anest-iwataeu.com
www.anest-iwataeu.com

ANEST IWATA Italia S.r.l.
46, Corso Vigevano 10155, Torino (Italy)
Tel. diretto +39 011 - 24 80 868 - Fax: +39 011 - 85 19 44
info@anest-iwata.it www.anest-iwata.it

ANEST IWATA Iberica
Calle de Les Teixidores, 3-5
08918 - Badalona (Barcelona)
Tel.: +34 933 20 59 93 - Fax.: +34 933 20 59 65
info@anest-iwata.es www.anest-iwata.es

ANEST IWATA Europe S.r.l.
NIEDERLASSUNG DEUTSCHLAND
Dorfäckerstr. 23/1, 74248 Ellhofen
Telefon: +49 (0) 7134-917368 - Fax: +49 (0) 7134 - 917378
Handy: +49 (0) 172 - 62 74 542
info@anest-iwata.de www.anest-iwata.de

European Sales Branches:

ANEST IWATA Scandinavia
Ögärdesvägen 6C, 433 30 PARTILLE - Sweden
Tel. +46 (0)31 - 340 28 60 - Fax +46 (0)31 - 340 28 69
info@anest-iwata.se www.anest-iwata.se

ANEST IWATA France
25 rue de Madrid - 38070 St Quentin Fallavier - France
Tél. +33 (0)4 - 74 94 59 69 - Fax +33 (0)4 - 74 94 34 39
info@anest-iwata.fr www.anest-iwata.fr

ANEST IWATA U.K.
Unit 10 Little End Road - Eaton Socon
St. Neots - CAMBRIDGESHIRE
PE19 8JH
Tel.: +44 (0) 1480 405419 Fax: +44 (0) 1480 217610
enquiries@anest-iwata.co.uk www.anest-iwata.co.uk

Manufactured by:
ANEST IWATA Corporation 3176,Shinyoshida-cho, Kohoku-ku, Yokohama, 223-8501 Japan

IMPORTANT SPECIFICATIONS

Max. Pressure: 7.0 bar (98 PSI)	Max. Temperature:
*Noise Level (LAeqT) WA101 78.7 dB (A) / WA101 R 62.8 dB (A)	Atmosphere 5 ~ 40 °C
WA200 81.2 dB (A) / WA200 WB 76.8 dB (A)	Air and fluid 5 ~ 43 °C
LPA200 76.9 dB (A)	Air connection: G 1/4"
	Fluid connection: G 1/4" (WA 101/101R/WA200 WB)
	Fluid connection: G 3/8" (WA200/LPA200)

*Measuring point: 1m backwards from gun, 1,6 m height

TECHNICAL SPECIFICATIONS

Model	Nozzle orifice mm (in)	Air cap set	*Atomizing air pressure bar (PSI)	Air pressure inside air cap bar (PSI)	Fluid output ml/min	Air consumption l/min (cfm)	Pattern width mm (in)	Weight g
High T.E.C. WA-101/101R Pressure feed								
WA-101-082P	0.8 (0.031)	E2P	3.0 (43)	-	150	270 (9.5)	190 (7.5)	460
WA-101-102P	1.0 (0.039)			-	200		220 (8.7)	
WA-101-132P	1.3 (0.051)	H2	-	-	250	260 (9.2)	230 (9.1)	440
WA-101R-05P	0.5 (0.020)	**Round	-	-	20	40 (1.4)	35 (1.4)	
High T.E.C. WA-200 Pressure feed								
WA-200-062	0.6 (0.024)	LV2	2.0 (29)	-	255	270 (9.5)	280 (11.0)	500
WA-200-084	0.8 (0.031)			-				
WA-200-104	1.0 (0.039)			-				
WA-200-124	1.2 (0.047)			-				
WA-200-154	1.5 (0.059)	G2P	3.0 (43)	-	500	530 (18.7)	400 (15.7)	550
WA-200-082P	0.8 (0.031)			-				
WA-200-102P	1.0 (0.039)			-				
WA-200-122P	*** 1.2 (0.047)			-				
WA-200-152P	1.5 (0.059)	K2	-	-	270	330 (11.7)	340 (13.4)	550
WA-200-202P	2.0 (0.079)	R2	-	-	400	360 (12.7)	320 (12.6)	
WA-200-251P	2.5 (0.098)	W1	-	-	500	360 (12.7)	330 (13.0)	
WA-200-066P FT	0.6 (0.024)	FT6	0.14	-	80	170 (6.0)	140 (5.5)	
WA-200-086P FT	0.8 (0.031)		0.16	-	100	185 (6.5)	150 (5.9)	
WA-200-106P FT	1.0 (0.039)		0.18	-	120	200 (7.1)	160 (6.3)	
WA-200-126P FT	1.2 (0.047)		0.20	-	140	220 (7.8)	180 (7.0)	
High T.E.C. WA-200 WB Pressure feed								
WA-200WB-081P	0.8 (0.031)	WB1	1.6 (31)	-	200	340 (12.1)	360 (14.2)	470
WA-200WB-101P	1.0 (0.039)			-	250		380 (14.9)	
WA-200WB-121P	1.2 (0.047)			-	300		340 (13.4)	
WA-200WB-141P	1.4 (0.055)			-				
WA-200WB-161P	1.6 (0.063)	-						
High T.E.C. LPA-200 Pressure feed								
LPA-200-122P	1.2 (0.047)	G2	2.0 (29)	0.7 (10)	500	500 (17.7)	300 (11.8)	500

*Atomizing air pressure means air pressure at gun inlet when trigger is pulled and air flows.

**The WA 101R air cap set is the purely round spray pattern with material flow control.

***0.8mm (0.031"), 1.0mm (0.039") nozzles are available.

SAFETY WARNINGS



FIRE OR EXPLOSION HAZARD

1. Spark and open flames are strictly prohibited.

Paints can be highly flammable and can cause fire.
Avoid any ignition sources such as smoking, open flames, electrical goods, etc.

2. Never use the following HALOGENATED HYDROCARBON SOLVENTS

which can cause cracks or dissolution on gun body (aluminium) by chemical reaction.
- Unsuitable solvents methyl chloride, dichloromethane, 1,2-dichloroethane, carbon tetrachloride, trichloroethylene, 1,1,1-trichloroethane.

- Be sure that all fluids and solvents are compatible with gun parts.
We are ready to supply a material list used in the product.

3. Securely ground spray gun. Use air hose with built-in ground wire or use grounded gun stay.

Ground resistance : Less than 1MΩ. Check the earth stability periodically.
If not, insufficient grounding can cause fire and explosion due to static electric sparking.



SPARE PARTS LIST

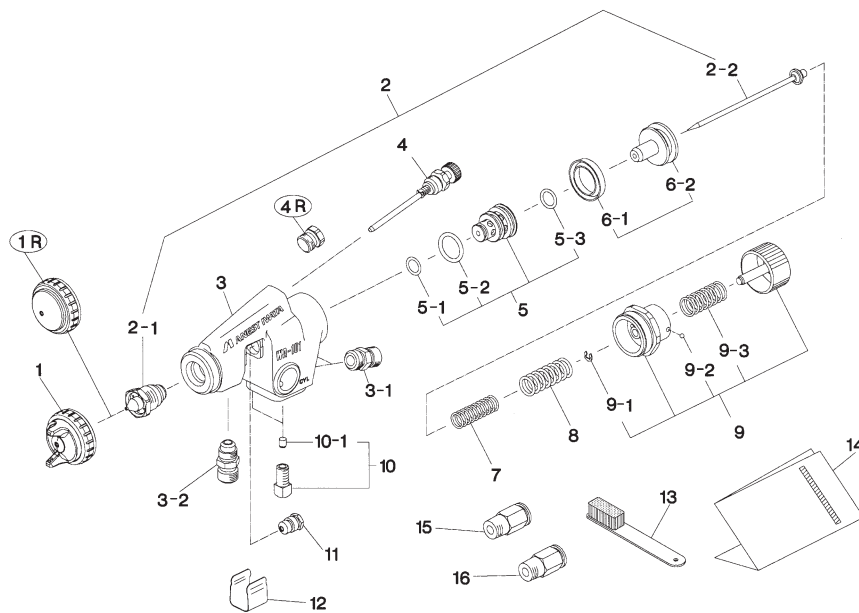







PARTS LIST

Ref.part	Description	WA 101	WA 101R	WA 200/WA 200WB	LPA 200
1	Air cap set	1	-	1	1
1R	● Air cap set (round)	-	1	-	-
2	Fluid nozzle + needle set	1	1	1	1
3	Body set	1		1	1
3-1	Air nipple			2	
3-2	Fluid nipple	1		1	1
4	Pattern adjustment	1	-	1	1
4R	Plug screw	-	1	-	-
5	Air valve seat			1	
5-1	O ring			1	
5-2	O ring			1	
5-3	O ring			1	
6-1	● Piston packing			1	
6-2	● Piston			1	
7	Needle spring			1	
8	Piston spring			1	
9	Fluid adj. set			1	
9-1	Stop ring			1	
9-2	Ball			1	
9-3	Fluid adj. spring			1	
10	Bolt set			2	
11	● Fluid needle packing set			1	
12	Cover			1	
13	Brush			1	
14	Instruction manual			1	
15	Half union for ø 6			1	
16	Half union for ø 8			1	

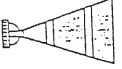
MODEL	FLUID NOZZLE		Fluid needle set
	Orifice	Mark	
WA 101	0.8 (0.031)	W101/08	WA12
WA 101	1.0 (0.039)	W101/10	WA12
WA 101R	0.5 (0.020)	W101/05	WA05
WA 200	0.8 (0.031)	W200/08	WA12
WA 200	1.0 (0.039)	W200/10	WA12
WA 200	1.2 (0.047)	W200/12	WA12
WA 200	1.5 (0.059)	W200/15	WA15
WA 200	2.0 (0.079)	W200/20	WA20
WA 200	2.5 (0.098)	W200/25	WA25
WA 200WB	0.8 (0.031)	200WB/08	WA12
WA 200WB	1.0 (0.039)	200WB/10	WA12
WA 200WB	1.2 (0.047)	200WB/12	WA12
WA 200WB	1.4 (0.055)	200WBS1/14	WA15
WA 200WB	1.6 (0.063)	200WB/16	WA15
LPA 200	1.8 (0.071)	L200/12	WA12

● Marked parts are wearable parts.
When ordering parts, specify gun's model, part name with ref.No.and marked No. of air cap set, fluid nozzle and fluid needle set. When replacing fluid nozzle or/and fluid needle please order fluid nozzle-needle set.

TROUBLESHOOTING

Spray Pattern	Problems	Remedies
 Fluttering	1. Air enters between fluid nozzle and tapered seat of gun body. 2. Air is drawn from fluid needle packing set 3. Air enters at fluid hose joint.	1. Remove fluid nozzle to clean seat. If it is damaged, replace nozzle. 2. Tighten fluid needle packing. 3. Fully tighten joint section.
 Crescent	1. Paint buildup on air cap partially clogs horn holes. Air pressure from both horns differs.	1. Remove obstructions from horn holes with attached brush. But do not use metal objects to clean horn holes.
 Inclined	1. Paint buildup or damage on fluid nozzle circumference and air cap center. 2. Fluid nozzle is not properly fitted.	1. Remove obstructions. Replace if damaged. 2. Remove fluid nozzle, clean seated section
 Split	1. Paint viscosity too low. 2. Fluid output too high.	1. Add paint to increase viscosity. 2. Tighten fluid adj. knob to reduce fluid output or turn pattern adj. knob clockwise.
 Heavy Center	1. Paint viscosity is too high. 2. Fluid output is too low.	1. Add thinner to reduce viscosity. 2. Turn fluid adj. knob counter-clockwise to increase fluid output.
 Spit	1. Fluid nozzle and fluid needle set are not seated properly. 2. Paint buildup inside air cap set.	1. Clean or replace fluid nozzle and fluid needle set. 2. Clean air cap set.

PROBLEMS AND REMEDIES

Problem	Where it occurred	Parts to be checked	Cause	Remedy			
				Retighten	Adjust	Clean	Replace
Air leaks (from tip of air cap)	Piston	Piston	*Dirt or damage wear on seat surface			x	x
		Air valve seat set	*Wear on needle spring			x	x
			*Wear on air valve spring				x
		O ring	*Damaged or deteriorated				x
Paint leaks	Fluid nozzle	Fluid nozzle - fluid needle set	*Dirt, damage, wear on seat surface			x	x
			*Loose fluid needle adj. knob		x		
			*Wear on needle spring				x
		Fluid nozzle - gun body	*Insufficient tightening	x			
			*Dirt or damage, wear on seat			x	x
		Fluid needle packing set-needle set	*Needle does not return due to packing set too tight		x		x
	*Needle does not return due to paint buildup on fluid needle				x	x	
Fluid needle	Needle packing set, needle set	*Wear	x			x	
	Packing seat	*Insufficient tightening	x				
Paint does not flow	Tip of gun	Fluid adj. knob	*Insufficient opening		x		
		Tip hole of nozzle	*Clogged			x	
		Paint filter	*Clogged			x	x

SAFETY WARNINGS



IMPROPER USE OF EQUIPMENT

- Never point gun towards people or animals.**
If done, it can cause inflammation of eyes and skin or bodily injury.
- Never exceed maximum operating pressure and maximum operating Temperature.**
- Be sure to release air and fluid pressures before cleaning, disassembling or servicing.**
If not, remaining pressure can cause bodily injury due to improper operation or scattering of cleaning liquid. In order to release pressure, first stop supply of compressed air, fluid and thinner to automatic spray gun. Next, supply only piston operating air and exhaust fluid by operating fluid needle, which results in automatic supply stop of all compressed air.
- Tip of fluid needle set has a sharp point.**
Do not touch the tip of fluid needle during maintenance for the protection of the human body.



PROTECTION OF HUMAN BODY

- Use in a well-ventilated site by using spray booth.**
If not, poor ventilation can cause organic solvent poisoning and catch fire.
- Always wear protective gear safety glasses, mask, gloves.**
If not, cleaning liquid, etc., can cause inflammation of eyes and skin. If you feel something wrong with eyes or skin, immediately see a doctor.
- Wear earplugs if necessary.**
Noise level can exceed 85 dB(A), depending on operating conditions and painting site



OTHER PRECAUTIONS

- Never alter this spray gun.**
If done, it can cause insufficient performance and failure.
- Enter working areas of other equipment (robots, reciprocators, etc.) after machines are turned off.**
If not, contact with them can cause injury.
- Never spray foods or chemicals through this gun.**
If done, it can cause accident by corrosion of fluid passages or adversely affect health by mixed foreign matter.
- If something goes wrong, immediately stop operation and find the cause. Do not use again until you have solved the problem.**

HOW TO CONNECT



CAUTION

- Use clean air filtered through air dryer and air filter.** If not, dirty air can cause painting failure.
- When you use this gun for the first time after purchasing, clean fluid passages spraying thinner and remove rust preventive oil.**
If not, remaining preventive oil can cause painting failure such as fish eyes.
- Use three-way solenoid valve of more than ø 4mm inner dia. cross-sectional area and air hose of over ø 6 mm inner dia. and less than 10m length.** If not, small dia. of solenoid valve and longer air hose between three-way solenoid valve and gun can cause delay in operation.
- Firmly fix hose to spray gun.** If not, disconnection of hose and drop of container can cause bodily injury.

1. Fit the gun to fitting stay, aim at spraying direction and fix it.
2. Connect atomizing air hose to atomizing air side (Cap marked side) and operating air hose to operating air side (CYL marked side).
3. Connect fluid hose to fluid inlet side.
4. Supply thinner to automatic gun. Spray and clean fluid passage with thinner.
5. Supply paint to automatic gun and test spray and adjust air volume, fluid output and pattern width as necessary.

Connecting example of air hose and fluid hose:

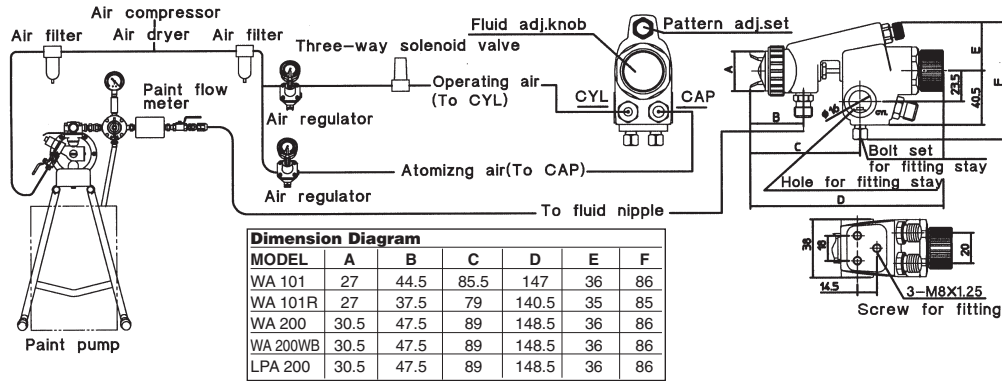

HOW TO INSTALL UNIONS FOR ATOMIZING AIR AND OPERATING AIR.

1. Remove air nipple for atomizing and operating from gun body.
2. Replace air nipple for atomizing (CAP marked side) and also replace air nipple for operating (CYL marked side) with half union for ϕ 8 mm air tube attached.
3. Be sure to connect half unions to the gun body tightly.

NOTE: Using air hose 12m (39.4ft) long, the inner diameter must be a minimum 8mm (0.315), so the gun can have the correct air volume to atomize at 0.7 bar (10PSI) inside air cap.

HOW TO OPERATE

1. Adjust operating air pressure from 3 to 4 bar (43 to 57 PSI).

NOTE: Valve orifice inside three-way solenoid valve should be minimum ϕ 4 mm (0.157 in) and also operating air hose length should be within 10m (32.8ft) with the inner diameter more than ϕ 6 mm (0.236 in) to avoid delayed operation and any kind of failure.

2. Although atomizing air pressure varies according to spray conditions, pull the piston of the gun with the pattern adj. set fully opened and adjust as specified in above specifications table.

Only in the case of the LPA 200 H.V.L.P gun, it will atomize within 0.7 bar (10 PSI) inside air cap.

3. Recommended paint viscosity differs according to paint property and painting conditions. 15 to 23 sec/Ford cup#4 is recommendable.

4. Set the spray distance from the gun to the work piece as near as possible within the range of 150_200 mm (5.9 to 7.9 in) with WA 101/101R, 200_250 mm (7.9 to 9.8 in) with WA 200/WA 200WB, and 100_200 mm (3.9 to 7.9 in) with LPA 200. As LPA 200 H.V.L.P. gun is operated at low air pressure, high transfer efficiency will not be obtained if the spray distance is too far.

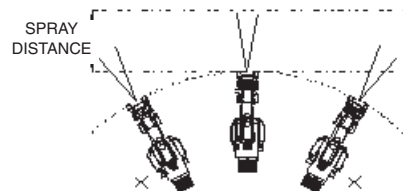

MAINTENANCE AND INSPECTION



WARNING

- First release air and fluid pressure fully according to item No. 3 of "Improper use of equipment" of WARNING on page 3.
- Tip of fluid needle set has a sharp point. Do not touch the tip of needle valve during maintenance for protection of the human body.
- Be careful not to damage the tip of the fluid nozzle or put your hand on it.
- Only an experienced person who is fully conversant with the equipment can do maintenance and inspection.



CAUTION

- Never use commercial or other parts instead of ANEST IWATA original spare parts.
- Never immerse the whole gun into liquid such as thinner.
- Never soak air cap set in solvent for extended period even if cleaning. It may cause defective pattern.
- Never damage holes of air cap, fluid nozzle or fluid needle.

Step-by-step procedure

1. Clean fluid passages and air cap set. Spray a small amount of thinner to clean fluid passages.
2. Clean each section with brush soaked with thinner and wipe out with waste cloth.
3. Before disassembly, fully clean fluid passages.
 - (1) Disassemble fluid nozzle. Use ring spanner, box wrench or optional exclusive spanner to disassemble fluid nozzle.
 - (2) Disassemble fluid needle set. Remove fluid adj. set and pull out fluid needle set from gun body. Pay attention so that spring does not suddenly fly out since fluid adj. set is strongly pushed by fluid needle spring and piston spring.
 - (3) Disassemble piston set. Screw rear section of fluid needle set into piston and pull out piston set.
4. When you want to adjust fluid needle packing set, first tighten it by hand while fluid needle set remains inserted. Then tighten it further about 1/6 turn (60-degrees) by spanner. When you remove needle packing set, do not leave plastic piece of needle packing set in the gun body.

Important

1. Incomplete cleaning can fail pattern shape and uniform particles. Especially clean fully and promptly after use with two-component paint.
2. Soaking whole spray gun in solvent may cause spray gun malfunction. When cleaning, never scratch any holes of air cap set and fluid nozzle, and fluid needle set.
3. During disassembly, do not scratch seat section.
 - (1) Remove fluid nozzle after removing fluid needle set or while keeping fluid needle pulled, in order to protect seat section.
 - (2) Pull fluid needle set after loosening fluid needle packing set to protect fluid needle packing set.
 - (3) Be careful not to damage piston packing when pulling out piston set.

4. Turn pattern adj. knob counterclockwise to fully open. And then tighten pattern adj. guide into gun body.

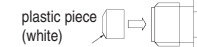

5. Apply Vaseline or oil to thread section of fluid adj. set and insert it into gun body set while keeping it fully opened.

4. If you tighten fluid needle packing set too much, fluid needle set will not move smoothly, resulting in paint leakage from tip of fluid nozzle. Try to adjust it carefully while pulling trigger and confirming movement of fluid needle set. When you tighten it too much, first loosen it and then tighten it again carefully.

5. If fluid adj. set is not fully opened, tip of it can contact and damage tip of gun body set and cause seizure of thread.

6. If fluid adj. set is not fully opened, tip seat section of it can contact and damage fluid nozzle and cause seizure of thread.

Where to inspect

1. Each hole passage of air cap and fluid nozzle
2. Packing and O ring
3. Leakage from seat section between fluid nozzle and fluid needle set

Parts replacement standard

1. Replace if it is crushed or deformed.
2. Replace if it is deformed or worn out.
3. Replace them if leakage does not stop after fully cleaning fluid nozzle and fluid needle set. If you replace fluid nozzle or fluid needle set only, fully match them and confirm that there is no leakage.